

# Data Sheet



Article number: 021500000104

Description: Sealing Clamp S 104 W1

## Measures

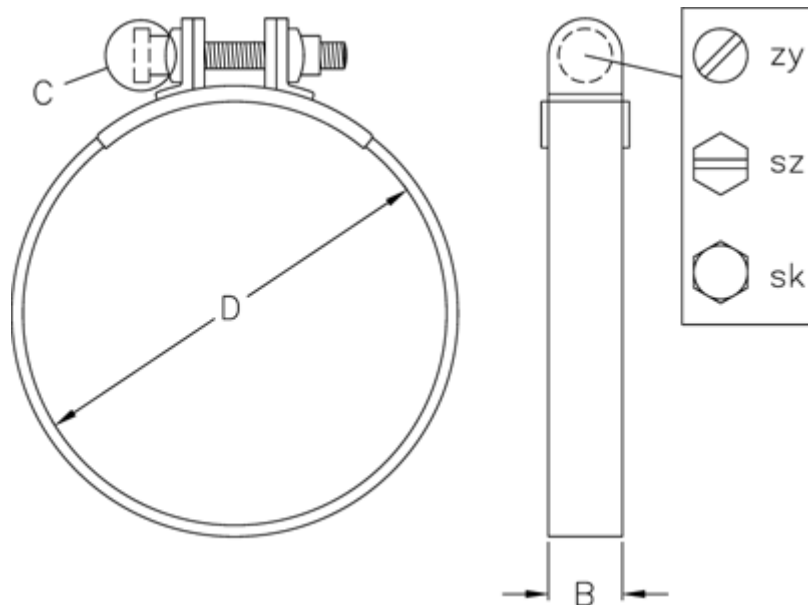

C (screw type)	= SZ
Diameter D	= 104
Width B	= 20